

**PROVEN PERFORMANCE**

Customers in over 60 countries and in diverse markets and sectors.

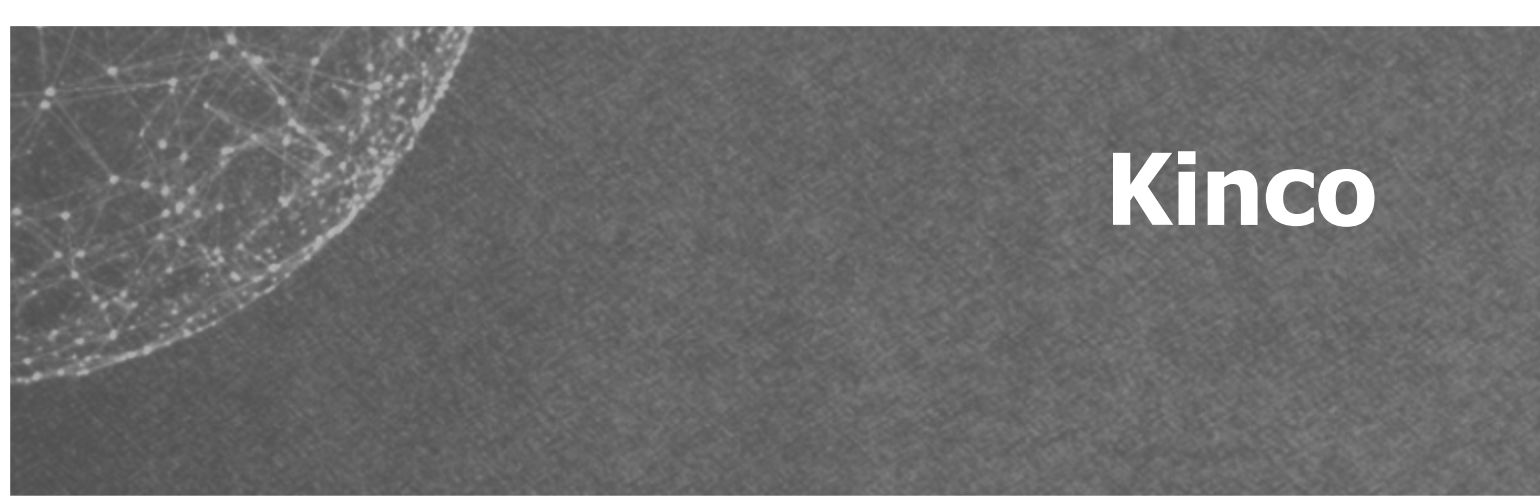

Motion  
Control  
Servo System

➔ **Servo System Catalog**

- FD5P Series Servo Drive
- Servo Motor



**Kinco® Automation**

en.kinco.cn Email: sales@kinco.cn

(All trademarks and logos in this brochure are property of and registered by their respective owners.)

K1E59-2403

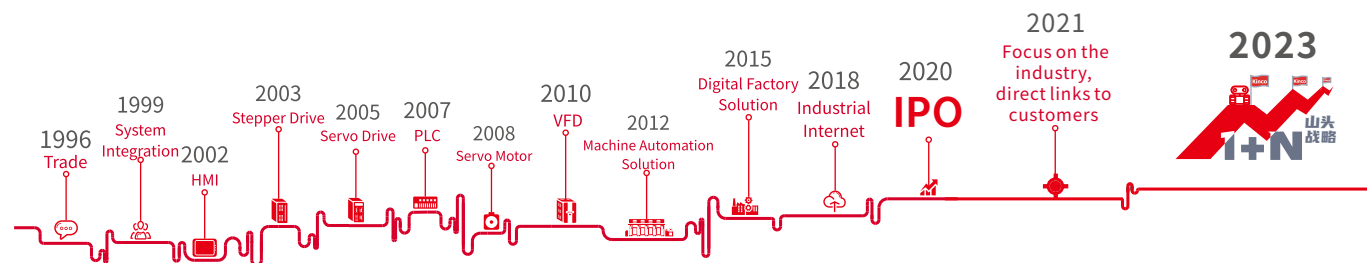

Shanghai Kinco Automation Co., Ltd. focuses on R&D, production, sales and technical services of automation standard products and intelligent hardware products, which is a leading supplier of machine automation and intelligent solutions for factories in China.

In 1996, Kinco has been providing total automation solutions for global industrial automation equipment manufacturers by relying on standard automation products such as HMI, servo system, stepping system, PLC, low-voltage inverter, etc. to penetrate into the industry, making China's automation solutions prevail all over the world. The company's HMI products have led the wave of HMI popularization in China, and its market share has maintained a leading position among local brand manufacturers for many years.

With the mission of "Making China's manufacturing become the top manufacturing in the world", Kinco company insists on investing a large amount of resources in the research and development of automated technology platforms, and sets up R&D facilities in Shanghai, Shenzhen and Changzhou. Kinco company has an automated technology platform that covers all aspects of control, drive, human-machine interaction, communication and electromechanical integration design. In the field of machine automation, Kinco focuses on the industry and has developed special solutions for logistics automation, service robots, medical instruments, professional drones, 3C machine tools, ozone and other industries.

In the field of smart factory, Kinco provides customers with the most easy-to-implement smart factory solutions for manufacturing companies at the field implementation level, PLC control and communication level, Scada and system integration level, and MES management level through its comprehensive automation technology platform and software system developed for smart factory.

With the vision of "creating a better life intelligently" and adhering to the values of "maintain conscience in growth and hold ingenuity in innovation", Kinco is a platform to help employees maximize their creative potential and a partner to help customers succeed in innovative management. We develop products and operate businesses with innovative thinking and practical spirit, adhere to ideals, and expect human creativity to make the world more wonderful.

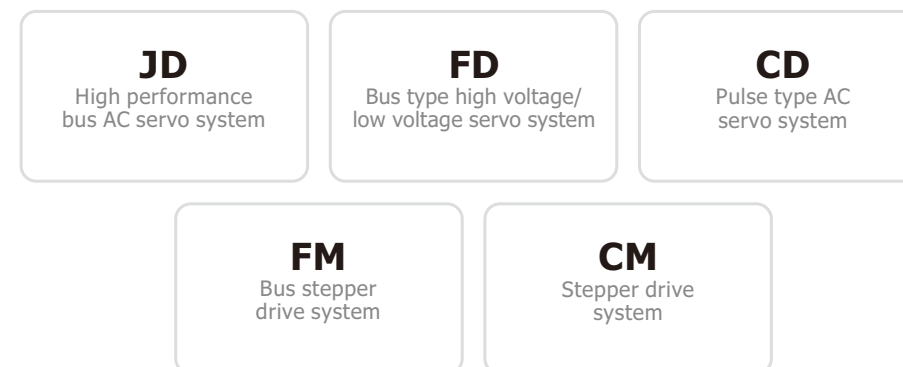

- Our design concept originated in Germany; support a variety of communication options such as pulse and Modbus/CANopen/EtherCAT/Profinet bus. It can drive all kinds of servo motors and stepper motors, including rotary servo motors, cable motors, direct drive motors, etc.
- It is widely used in the logistics AGV, 3C, medical, new energy, and machine registry industries.
- The product meets international quality and design standards, which is the first choice for international brand servo ODM.

- 03 SUMMARIZE
  - Drive characteristics
  - Naming rules for drives and motors/cables
  - FD5P drive model list
  - SMK series servo motor model list
- 08 DRIVE INTRODUCTION
  - Parameters table
  - Drive and motor configuration table
  - Wiring diagram
  - Description of external wiring and communication terminals
  - Mechanical dimension
- 16 MOTOR INTRODUCTION
  - Motor characteristics
  - Mechanical dimension
  - Torque-velocity curve
  - Connector and wiring at the motor end
  - Parameter table
- 22 MOTOR CABLE CONNECTION TABLE
  - Encoder cable
  - Motor power cable
  - Brake cable



# FD5P high performance AC servo

Driving intelligent equipments towards new trends

**PK series** **New platform**

**NEW**



EtherCAT CANopen Modbus

- ☑ Suitable for high protection scenarios, with motor protection level up to IP67;
- ☑ Vibration suppression, smooth operation, safe and reliable;
- ☑ Reliable quality and automated production;
- ☑ Power planning covers 50W-7.5KW;
- ☑ High responsiveness, with a speed loop sampling frequency of up to 8KHz.

## FD5P Feature

### 1. Equipped with a brand new platform

Equipped with a new platform, the main frequency of the new chip has increased by 2.4 times. The Current loop can reach 16KHz, the speed loop can reach 8KHz, the position loop can reach 4KHz, and the speed loop response bandwidth can reach 3.5KHz.

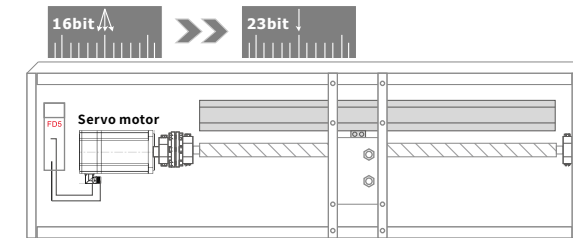

### 2. Accurate positioning

It can be paired with a 23 bit encoder to improve the positioning accuracy and response speed of the entire servo system, effectively improving production yield and efficiency. Among them, the highest positioning accuracy can reach  $\leq \pm 5''$ .

### 3. Vibration suppression, stable operation

The driver reduces the speed oscillation generated by the motor during operation by using FFT multi-point notch filters (which can be used simultaneously with 4), effectively suppressing the large amplitude vibration generated by equipment operation. It is particularly suitable for high-speed movement, workpiece transportation, precise assembly, cantilever handling, and other occasions, helping the equipment operate quickly and smoothly.

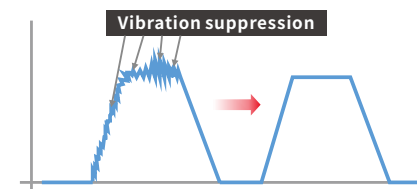

### 4. Smooth operation, safe and reliable

The driver supports one click activation of S-curve control function without command delay. It can be applied to the positioning control of equipment with large inertia or flexible equipment, ensuring smooth and safe operation of the equipment during sudden acceleration and deceleration, effectively overcoming mechanical vibration caused by sudden speed changes, and reducing impact force.

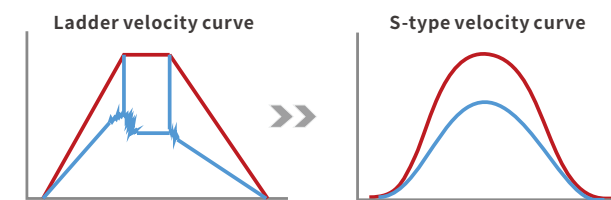

### 5. The coverage is larger and wider, supporting multiple bus communication.

Based on Kinco's previous generation AC servo driver platform, a new upgrade has been carried out, with a power range of 50W-7.5KW, which is fully compatible and can be replaced. The drive supports CANopen, EtherCAT, and Modbus bus control.

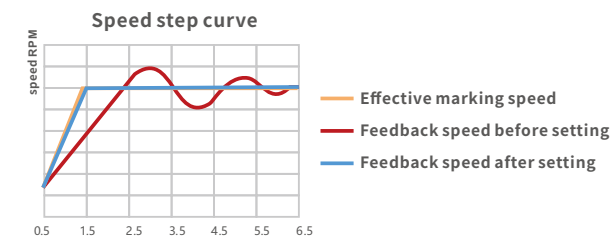

### 6. EASY Tune optimization and upgrading+online Self-tuning

The servo system has a built-in online Self-tuning module. It only takes a few simple steps to set the mechanical stiffness, so that the load change under acceleration and deceleration can be automatically calculated during the operation of the equipment, and the PID parameters can be dynamically adjusted in real time according to the feedback load, the mechanical stiffness set and the application type, without any complicated parameter setting.

## Drive and motor/cable naming rules

Drive: **FD425P-EA-000**

① ② ③ ④ ⑤ ⑥



①-Series Name FD: FD series

④-Drive version 5P: Fifth generation drive enhanced version

②-Supply voltage 4: Input Voltage AC220V

⑤-Control mode EA: RS232, EtherCAT, pulse  
CA: RS232, CAN, pulse  
LA: RS232, RS485, pulse

Note: FD425P - □ F-000 comes with a fan

③-Drive current : 1:AC220V 400W 3.2A  
2:AC220V 750W 4A  
3:AC220V 1000W 5A

⑥-Software Version 000: Software Version Number

Motor: **SMK60S-0040-30MAK-5LSA**

① ② ③ ④ ⑤ ⑥ ⑦ ⑧ ⑨ ⑩ ⑪ ⑫



①-Series name SMK: Common body series

⑥-Encoder type  
M: Singleturn communication type magnetoelectric encoder  
Q: Multiturn communication type magnetoelectric absolute encoder  
V: Singleturn communication type optical encoder  
Y: Multiturn communication type optical absolute encoder

②-Flange  
40:40x40(mm)  
60:60x60(mm)  
80:80x80(mm)

⑦-Brake holder A: Without brake  
B: With brake

③-Inertia type S: Small inertia

⑧-Output shaft style K: With key  
K: Key

④-Rated power :  
0005: 10x5(W)  
0010: 10x10(W)  
0020: 10x20(W)  
0040: 10x40(W)  
0075: 10x75(W)  
0100: 10\*100(W)

⑨-Number of polar pairs 5:5

⑩- Supply voltage : L:AC220V

⑪- Motor version number: S: S version

⑤-Rated speed : 30:30x100(rpm)

⑫- Motor Outlet Type: A: Special socket for common motor

## Drive and motor/cable naming rules

Power cable: **MOTF-005-LL-KA-B**

① ② ③ ④ ⑤ ⑥

①-Cable function type MOT: Motor power cable

④-Cable length 03:3m/05:5m/ 10:10m/15:15m

②-Cable type F: Flexible cable  
empty: Common cable

⑤-Motor outlet type KA: Pluggable motor connector

③-Rated current 005:5A

⑥-Cable Note  
B: The power cable includes the brake cable  
NS: The power cable does not include conventional cables for brakes  
Empty: The power cable does not include high shielding cables for brakes

Note: MFT-005-LL-KAB-S is the SMK40 series brake power line

Encoder cable: **ENC DGF-LL-GA-DC**

① ② ③ ④ ⑤ ⑥ ⑦ ⑧

①-Cable function type ENC: Motor encoder cable

⑤-Cable length 03:3m/05:5m/ 10:10m/15:15m

②-Drive encoder connector type D: 1394 connector

⑥-Core cable type G: 6-core cable

③-Drive connector definition  
G: Communication type connector

⑦-Type of encoder connector to the motor end  
A: Pluggable encoder connector

④-Cable type F: Flexible Cable  
empty: Common Cable

⑧ Cable accessories  
DC: With battery box outlet wire  
Empty: Without battery box outlet wire

Band brake extension cable: **BRA-LL-2PIN**

① ② ③

① - Cable function type BRA: Motor brake extension cable

② - Cable length (5) :0.5m/01:1m

③ - Joint type 2PIN: 2PIN connector

## FD5P Drive Model List

Series	Specification Model	Wattage (W)	Supply voltage	Maximum continuous output current (rms) (A)	Peak current(A)	Control mode	weight (Kg)	Dimension L*W*H (mm)
FD5P Series	FD415P-LA-000	50~400	AC220V	3.2	15	Pulse, RS485	0.881	160*153*40
	FD415P-CA-000					Pulse, CANopen		
	FD415P-EA-000					Pulse, EtherCAT		
	FD425P-LA-000	750		4	18	Pulse, RS485	1.5	160*153*55
	FD425P-CA-000					Pulse, CANopen		
	FD425P-EA-000					Pulse, EtherCAT		
	FD425P-LF-000	1KW		5	18	Pulse, RS485	1.5	160*153*55
	FD425P-CF-000					Pulse, CANopen		
FD425P-EF-000	Pulse, EtherCAT							

## SMC Series Servo Motor Model List

Series	Specification Model	Rated Wattage Pn(W)	Rated torque Tn(Nm)	Rated speed nN(rpm)	Rated current Arms(A)	Shaft diameter (mm)	Fuselage length (mm)	
							■=A	■=B (Brake motor)
40 Flange	SMK40S-0005-30□■K-5LSA	50	0.16	3000	0.88	8	62.5 ± 1	92.5 ± 1
	SMK40S-0010-30□■K-5LSA	100	0.32		1.2	8	75 ± 1	105 ± 1
60 Flange	SMK60S-0020-30□■K-5LSA	200	0.64		1.55	14	77 ± 1.5	109 ± 1.5
	SMK60S-0040-30□■K-5LSA	400	1.27		2.93	14	95 ± 1.5	127.1 ± 1.5
80 Flange	SMK80S-0075-30□■K-5LSA	750	2.39		3.9	19	103.7 ± 1.5	133.2 ± 1.5
	SMK80S-0100-30□■K-5LSA	1000	3.18		5	19	113.7 ± 1.5	143.2 ± 1.5

Note: □=V : Singleturn communication type optical encoder  
 Y : Multiturn communication type optical absolute encoder  
 M : Singleturn communication type magnetoelectric encoder  
 Q : Multiturn communication type magnetoelectric absolute encoder  
 ■=A : Motor without brake  
 ■=B : Motor with brake

## FD5P Servo drive technical parameters table



Model Parameters	FD5P Series		
	FD415P-□A-000	FD425P-□A-000	FD425P-□F-000
Power supply	Power Supply	1PH 200-240VAC ±10% 50/60Hz ±3HZ	
	Logic power supply	None	
Current	Maximum continuous output current (rms)	3.2A	5A
	Peak current (PEAK)	15Ap	18Ap
	Feedback Signal	Singleturn communication type magnetoelectric encoder, Multiturn communication type magnetoelectric absolute value encoder, Singleturn communication type photoelectric encoder, Multiturn communication type photoelectric absolute value encoder	
Energy consumption brake	No built-in braking resistor, The actual power exceeds the limit power and requires an external braking resistor (depending on the operating conditions, mainly used in the case of rapid start and stop)."		
Energy consumption braking voltage absorption point	DC380V ±5V		
Overvoltage alarm voltage	DC400V ±5V		
Undervoltage alarm voltage	DC200V ±5V		
Cooling method	Natural cooling		Cooling method: Forced air cooling
Weight (KG)	0.881	1.5	1.5
Location Control Mode	Command control mode	External pulse input control, Control of 8-segment position using DIN signal, Communication setting internal object parameter control	
	Command smoothing mode	Low-pass filtering (set by internal parameters), S-curve smoothing filtering (set by internal parameters in 1 mode)	
	Pulse command mode	Pulse+direction, CCW+CW, A-phase+B-phase (3.0V~30V, max. 500KHz)	
	Maximum input pulse frequency	Differential transmission mode: up to 4MHz, open collector transmission mode: 500KHz	
	Electronic gear ratios	Setting range Gear factor: ~32768~32767, Gear divider: 1~32767, 1/50 ≤  Gear factor/Gear divider  ≤ 50"	
	Torque limit	Internal parameter setting	
	Feedforward gain	0~100.0% (Internal parameter setting)	
Position loop sampling frequency	4KHz		
Speed Control Mode	Command control mode	8-segment speed control using DIN signals, Communication settings internal object parameter control"	
	Command smoothing mode	Low-pass filtering (Internal parameter setting)	
	Speed limit	Internal parameter setting	
	Torque limit	Internal parameter setting	
	Speed loop sampling frequency	8KHz	
Torque Control Mode	Command control mode	Communication setting internal object parameter control	
	Command smoothing mode	Low-pass filtering (Internal parameter setting)	
	Speed limit	Internal parameter setting	
	Current loop sampling frequency	16KHz	
Digital Input	Input specification	7 digital inputs, through the connection of COM1 terminal, it can be valid at high level (12.5~30V) or valid at low level (0~5V).	
	Input function	The following functions can be defined according to your needs: drive enable, drive error reset, drive working mode control, speed loop proportional control, positive limit, negative limit, origin signal, command reverse, internal speed segment control, internal position segment control, emergency stop, pause, start to find the origin, command activation, wheel ratio switching, gain switching, position table function, clear pulse function, etc	
Digital Output	Output specification	The following functions can be defined according to your needs: drive ready, drive error, motor position arrives, motor zero speed, motor holding brake, motor speed arrives, index Z signal appears, speed reaches limit, torque reaches setting, motor lock Axis, motor limit, origin found, multi-segment position, etc.	
	Output function	The following functions can be defined according to your needs: drive ready, drive error, motor position arrives, motor zero speed, motor holding brake, motor speed arrives, index Z signal appears, speed reaches limit, torque reaches setting, motor lock Axis, motor limit, origin found, multi-segment position, etc.	
Encoder signal output function	Output 5V motor A, B, Z signals, frequency division output range 0 ~ 65536; used for multi-axis synchronization, maximum output frequency 5MHz		
Protection function	Over-voltage protection, under-voltage protection, motor overheating (I2T) protection, short-circuit protection, drive overheating protection, etc.		
Standard	CE, IEC61800-5-1		
RS232	RS232 (connection with PC: RS-232 serial port to Mini_USB)		
RS485	Maximum support 115.2KHz baud rate, can use Modbus RTU protocol to communicate with the controller		
CANopen	Maximum support 1MHz baud rate, can use CANopen protocol to communicate with the controller		
EtherCAT	Support CoE (CiA402 protocol) and CSP/CSV/PP/PV/PT/HM mode, communication rate 100M		
Operation Environment	Operation temperature	0~40°C	
	Storage temperature	10°C~70°C	
	Humidity (no condensation)	5~95%	
	Protection level	IP20	
	Installation site	Dust-free, dry, lockable (e.g. electrical cabinets)	
	Installation method	Vertical installation	
	Installation altitude	When the rated working altitude is below 1000m and the working altitude is above 1000m, a derating of 1.5% is required for every 100 meters increase. The maximum working altitude is 4000 meters above sea level.	
Atmosphere pressure	86kpa~106kpa		

Note: □=L: RS232, RS485, Pulse  
 □=C: RS232, CAN, Pulse  
 □=E: RS232, EtherCAT, Pulse

# FD5P servo drive and motor configuration table

Rated power/Rated speed/ Rated torque	Servo motor	Description	Power cable Brake cable	Encoder cable	Servo drive		
					Pulse EtherCAT	Pulse CANopen	Pulse Modbus 485
50W/3000rpm/0.16Nm	SMK40S-0005-30MAK-5LSA	Singleturn communication type magnetoelectric encoder motor	MOT-005-LL-KA	ENCDG-LL-GA	FD415P-EA-000	FD415P-CA-000	FD415P-LA-000
	SMK40S-0005-30MBK-5LSA	Singleturn communication type magnetoelectric encoder brake motor	MOTF-005-LL-KAB-S/BRA-LL-2PIN				
100W/3000rpm/0.32Nm	SMK40S-0010-30MAK-5LSA	Singleturn communication type magnetoelectric encoder motor	MOT-005-LL-KA				
	SMK40S-0010-30MBK-5LSA	Singleturn communication type magnetoelectric encoder brake motor	MOTF-005-LL-KAB-S/BRA-LL-2PIN				
200W/3000rpm/0.64Nm	SMK60S-0020-30MAK-5LSA	Singleturn communication type magnetoelectric encoder motor	MOT-005-LL-KA				
	SMK60S-0020-30MBK-5LSA	Singleturn communication type magnetoelectric encoder brake motor	MOT-005-LL-KA-B/BRA-LL-2PIN				
400W/3000rpm/1.27Nm	SMK60S-0040-30MAK-5LSA	Singleturn communication type magnetoelectric encoder motor	MOT-005-LL-KA				
	SMK60S-0040-30MBK-5LSA	Singleturn communication type magnetoelectric encoder brake motor	MOT-005-LL-KA-B/BRA-LL-2PIN				
750W/3000rpm/2.39Nm	SMK80S-0075-30MAK-5LSA	Singleturn communication type magnetoelectric encoder motor	MOT-005-LL-KA		FD425P-EA-000	FD425P-CA-000	FD425P-LA-000
	SMK80S-0075-30MBK-5LSA	Singleturn communication type magnetoelectric encoder brake motor	MOT-005-LL-KA-B/BRA-LL-2PIN				
1000W/3000rpm/3.18Nm	SMK80S-0100-30MAK-5LSA	Singleturn communication type magnetoelectric encoder motor	MOT-005-LL-KA				
	SMK80S-0100-30MBK-5LSA	Singleturn communication type magnetoelectric encoder brake motor	MOT-005-LL-KA-B/BRA-LL-2PIN				
50W/3000rpm/0.16Nm	SMK40S-0005-30QAK-5LSA	Multiturn communication type magnetoelectric absolute value encoder motor	MOT-005-LL-KA	ENCDG-LL-GA-DC/BAT-FD5	FD415P-EA-000	FD415P-CA-000	FD415P-LA-000
	SMK40S-0005-30QBK-5LSA	Multiturn communication type magnetoelectric absolute value encoder holding motor	MOTF-005-LL-KAB-S/BRA-LL-2PIN				
100W/3000rpm/0.32Nm	SMK40S-0010-30QAK-5LSA	Multiturn communication type magnetoelectric absolute value encoder motor	MOT-005-LL-KA				
	SMK40S-0010-30QBK-5LSA	Multiturn communication type magnetoelectric absolute value encoder holding motor	MOTF-005-LL-KAB-S/BRA-LL-2PIN				
200W/3000rpm/0.64Nm	SMK60S-0020-30QAK-5LSA	Multiturn communication type magnetoelectric absolute value encoder motor	MOT-005-LL-KA				
	SMK60S-0020-30QBK-5LSA	Multiturn communication type magnetoelectric absolute value encoder holding motor	MOT-005-LL-KA-B/BRA-LL-2PIN				
400W/3000rpm/1.27Nm	SMK60S-0040-30QAK-5LSA	Multiturn communication type magnetoelectric absolute value encoder motor	MOT-005-LL-KA				
	SMK60S-0040-30QBK-5LSA	Multiturn communication type magnetoelectric absolute value encoder holding motor	MOT-005-LL-KA-B/BRA-LL-2PIN				
750W/3000rpm/2.39Nm	SMK80S-0075-30QAK-5LSA	Multiturn communication type magnetoelectric absolute value encoder motor	MOT-005-LL-KA		FD425P-EA-000	FD425P-CA-000	FD425P-LA-000
	SMK80S-0075-30QBK-5LSA	Multiturn communication type magnetoelectric absolute value encoder holding motor	MOT-005-LL-KA-B/BRA-LL-2PIN				
1000W/3000rpm/3.18Nm	SMK80S-0100-30QAK-5LSA	Multiturn communication type magnetoelectric absolute value encoder motor	MOT-005-LL-KA				
	SMK80S-0100-30QBK-5LSA	Multiturn communication type magnetoelectric absolute value encoder holding motor	MOT-005-LL-KA-B/BRA-LL-2PIN				
50W/3000rpm/0.16Nm	SMK40S-0005-30VAK-5LSA	Singleturn communication type optical encoder motor	MOT-005-LL-KA	ENCDG-LL-GA	FD415P-EA-000	FD415P-CA-000	FD415P-LA-000
	SMK40S-0005-30VBK-5LSA	Singleturn communication type optical encoder brake motor	MOTF-005-LL-KAB-S/BRA-LL-2PIN				
100W/3000rpm/0.32Nm	SMK40S-0010-30VAK-5LSA	Singleturn communication type optical encoder motor	MOT-005-LL-KA				
	SMK40S-0010-30VBK-5LSA	Singleturn communication type optical encoder brake motor	MOTF-005-LL-KAB-S/BRA-LL-2PIN				
200W/3000rpm/0.64Nm	SMK60S-0020-30VAK-5LSA	Singleturn communication type optical encoder motor	MOT-005-LL-KA				
	SMK60S-0020-30VBK-5LSA	Singleturn communication type optical encoder brake motor	MOT-005-LL-KA-B/BRA-LL-2PIN				
400W/3000rpm/1.27Nm	SMK60S-0040-30VAK-5LSA	Singleturn communication type optical encoder motor	MOT-005-LL-KA				
	SMK60S-0040-30VBK-5LSA	Singleturn communication type optical encoder brake motor	MOT-005-LL-KA-B/BRA-LL-2PIN				
750W/3000rpm/2.39Nm	SMK80S-0075-30VAK-5LSA	Singleturn communication type optical encoder motor	MOT-005-LL-KA		FD425P-EA-000	FD425P-CA-000	FD425P-LA-000
	SMK80S-0075-30VBK-5LSA	Singleturn communication type optical encoder brake motor	MOT-005-LL-KA-B/BRA-LL-2PIN				
1000W/3000rpm/3.18Nm	SMK80S-0100-30VAK-5LSA	Singleturn communication type optical encoder motor	MOT-005-LL-KA				
	SMK80S-0100-30VBK-5LSA	Singleturn communication type optical encoder brake motor	MOT-005-LL-KA-B/BRA-LL-2PIN				
50W/3000rpm/0.16Nm	SMK40S-0005-30YAK-5LSA	Multiturn communication type photoelectric absolute value encoder motor	MOT-005-LL-KA	ENCDG-LL-GA-DC/BAT-FD5	FD415P-EA-000	FD415P-CA-000	FD415P-LA-000
	SMK40S-0005-30YBK-5LSA	Multiturn communication type photoelectric absolute value encoder brake motor	MOTF-005-LL-KAB-S/BRA-LL-2PIN				
100W/3000rpm/0.32Nm	SMK40S-0010-30YAK-5LSA	Multiturn communication type photoelectric absolute value encoder motor	MOT-005-LL-KA				
	SMK40S-0010-30YBK-5LSA	Multiturn communication type photoelectric absolute value encoder brake motor	MOTF-005-LL-KAB-S/BRA-LL-2PIN				
200W/3000rpm/0.64Nm	SMK60S-0020-30YAK-5LSA	Multiturn communication type photoelectric absolute value encoder motor	MOT-005-LL-KA				
	SMK60S-0020-30YBK-5LSA	Multiturn communication type photoelectric absolute value encoder brake motor	MOT-005-LL-KA-B/BRA-LL-2PIN				
400W/3000rpm/1.27Nm	SMK60S-0040-30YAK-5LSA	Multiturn communication type photoelectric absolute value encoder motor	MOT-005-LL-KA				
	SMK60S-0040-30YBK-5LSA	Multiturn communication type photoelectric absolute value encoder brake motor	MOT-005-LL-KA-B/BRA-LL-2PIN				
750W/3000rpm/2.39Nm	SMK80S-0075-30YAK-5LSA	Multiturn communication type photoelectric absolute value encoder motor	MOT-005-LL-KA		FD425P-EA-000	FD425P-CA-000	FD425P-LA-000
	SMK80S-0075-30YBK-5LSA	Multiturn communication type photoelectric absolute value encoder brake motor	MOT-005-LL-KA-B/BRA-LL-2PIN				
1000W/3000rpm/3.18Nm	SMK80S-0100-30YAK-5LSA	Multiturn communication type photoelectric absolute value encoder motor	MOT-005-LL-KA				
	SMK80S-0100-30YBK-5LSA	Multiturn communication type photoelectric absolute value encoder brake motor	MOT-005-LL-KA-B/BRA-LL-2PIN				



# Drive external wiring diagram

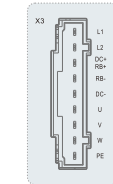
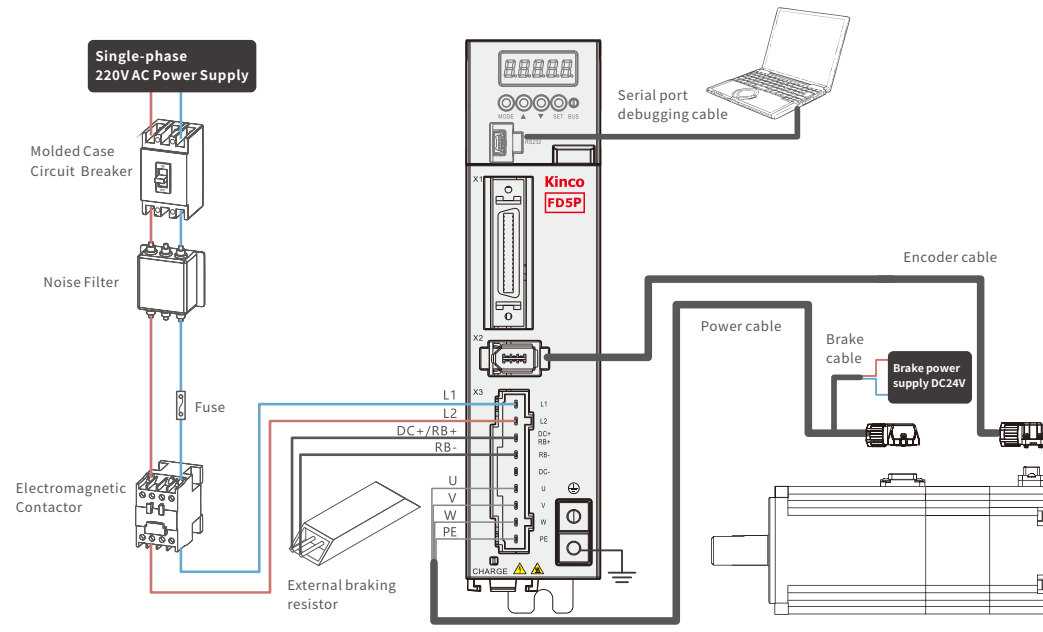

Interface number	Interface name	Interface type	Pin number	Signal marking	Signal name	Specification description	
X3	Power terminals	9P/5mm Plug-in terminals	1	L1	Power supply input	1PH 200-240VAC 50/60Hz	
			2	L2			
			3	DC+/RB1	DC bus,Braking resistance interface		
			4	RB-			
			5	DC-			
			6	U	Motor cable interface		Connect to motor cable U, V, W, PE
			7	V			
			8	W			
			9	PE			

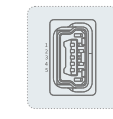

Interface number	Interface name	Interface type	Pin number	Signal marking	Signal name	Specification description
RS232	RS232 communication interface	Mini_USB 5pin terminal	1	NC		It can be connected to the host computer software of the PC side to set parameters and monitor the status
			2	RX	Drive data reception	
			3	TX	Drive data sending	
			4	NC		
			5	GND	Signal site	

Note: Customers can choose the Kinco servo debugging cable-MINIUSB, model PDC-USBM-1 (5)

# Communication port description of the drive

# Communication port description of the drive

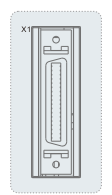

Interface number	Interface name	Interface type	Pin number	Signal marking	Signal name	Specification description
X1	I/O Interface	SCSI-36P-F	1	OUT1+	Digital output port 1 positive	Open-collector output, maximum voltage DC30V, maximum current 100mA
			3	OUT1-	Digital output port 1 negative	
			5	OUT2+	Digital output port 2 positive	
			7	OUT2-	Digital output port 2 negative	
			9	OUT3	Digital output port 3	
			11	OUT4	Digital output port 4	
			20	OUT5	Digital output port 5	
			13	COMO	Digital output port 3, 4, 5 common site	
			15	VDD	External output power supply positive	Internal 24V power output, voltage range +/-20%, maximum current DC200mA
			17	VEE	External output power supply negative	
			2	COMI	Digital input common	Digital input to common positive terminal, accepts power supplies from 18 ~ 30 VDC
			4	DIN1	Digital input port 1	The COMI-DINx signal is valid if the difference is greater than 12.5V, and is not valid if it is less than 5V. Receives relay output signals as well as NPN signals, maximum input frequency: 1 KHz
			6	DIN2	Digital input port 2	
			8	DIN3	Digital input port 3	
			10	DIN4	Digital input port 4	
			12	DIN5	Digital input port 5	
			14	DIN6	Digital input port 6	
			16	DIN7	Digital input port 7	
			19	MA/	TTL signal: MA+, MA-MB+, MB-, MZ+, MZ-, Support the highest frequency 500KHz, voltage range DC3.3-30V Differential signal: MA, MA, MB, MB, MZ, MZ, Support maximum frequency 4MHz, voltage range DC 3.3-5V	MA, MB, MZ, MA/, MB/, MZ/ support 5V RS422 differential Signal input, maximum pulse frequency 4MHz, optional signal type: ① Pulse+Direction (PLS+DIR) ② Forward and reverse pulses (CW/CCW) ③ A+B phase
			21	MB/		
			23	MZ/		
			25	NC		
			27	MA+ / MA		
			29	MA-		
			31	MB+ / MB		
			33	MB-		
			35	MZ+ / MZ		
			18	MZ-		
			22	+5V	Internal 5V power output	
			24	GND		
			26	ENCO_N	Encoder signal output	Output 5V motor A, B, Z signals, frequency division output range 0~65536; For multi-axis synchronization, the maximum output frequency is 5MHz
			28	ENCO_N		
			30	ENCO_B		
			32	ENCO_B		
			34	ENCO_A		
			36	ENCO_A		

Note: FDXX5-PA-000 supports 5 channels of input and 3 channels of output (ie: DIN5, DIN6, OUT4, OUT5 are empty)



Interface number	Interface name	Interface type	Pin number	Signal marking	Signal name	Specification description
X2	Motor encoder interface F	1394 Master saet	1	+5V	5V positive power supply output	Encoder signal input
			2	GND	5V negative power supply output	
			3	CLOCK+	Positive end of the clock signal	
			4	CLOCK-	Negative end of the clock signal	
			5	SD+	Data signal	
			6	SD-	Data signal	

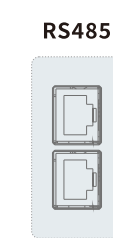

Interface number	Interface name	Interface type	Pin number	Signal marking	Signal name	Interface number	Interface name	Interface type	Pin number	Signal marking	Signal name
X4A	RS485 communication interface input	RJ45 Master Network Port	L1	NC		X4B	RS485 communication interface input	RJ45 Master network port	R1	NC	
			L2	NC					R2	NC	
			L3	NC					R3	NC	
			L4	485-	Data acceptance negative end				R4	485-	Data acceptance negative end
			L5	485+	Data receiving positive end				R5	485+	Data receiving positive end
			L6	NC					R6	NC	
			L7	NC					R7	NC	
			L8	NC					R8	NC	

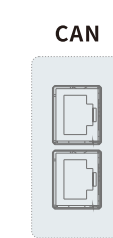

Interface number	Interface name	Interface type	Pin number	Signal marking	Signal name	Interface number	Interface name	Interface type	Pin number	Signal marking	Signal name
X4A	CAN communication interface input	RJ45 Master Network Port	L1	CAN_H	Positive end of the signal	X4B	CAN communication interface input	RJ45 Master network port	R1	CAN_H	Positive end of the signal
			L2	CAN_L	Negative end of the signal				R2	CAN_L	Negative end of the signal
			L3	GNDB	Signal site				R3	GNDB	Signal site
			L4	NC					R4	NC	
			L5	NC					R5	NC	
			L6	NC					R6	NC	
			L7	NC					R7	NC	
			L8	NC					R8	NC	

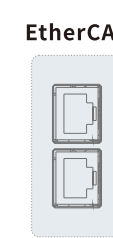

Interface number	Interface name	Interface type	Pin number	Signal marking	Signal name	Interface number	Interface name	Interface type	Pin number	Signal marking	Signal name
X4A	EtherCAT communication interface input	RJ45 Master network port	L1	TD+	Receive signal positive end	X4B	EtherCAT communication interface input	RJ45 Master network port	R1	TD+	Data receiving positive end
			L2	TD-	Receive signal negative end				R2	TD-	Data receiving Negative end
			L3	RD+	Sending signal positive end				R3	RD+	Send signal positive terminal
			L4	NC					R4	NC	
			L5	NC					R5	NC	
			L6	RD-	Sending signal negative end				R6	RD-	Send signal negative terminal
			L7	NC					R7	NC	
			L8	NC					R8	NC	

# Mechanical dimension diagram of servo drive

## FD415P-□A-000 Dimensional Drawing (Unit: mm)

Note: Wiring space needs to be reserved around the driver, it is recommended to be greater than 70mm.

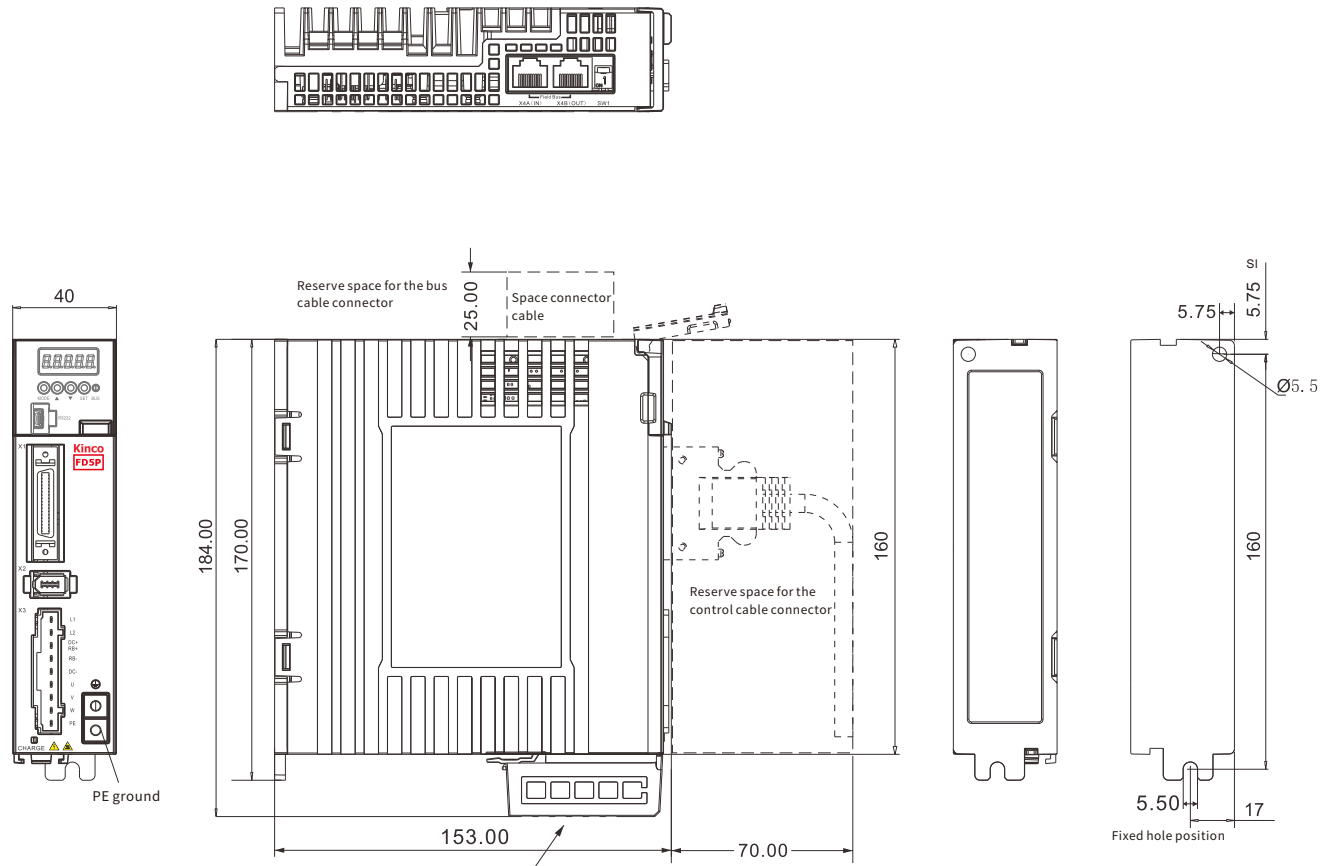

Note: The FD5P battery pack (BAT-FD fault) is suitable for the absolute encoder motor and is compatible with ENCDG-LL-GA-DC

# Mechanical dimension diagram of servo drive

## FD425P-□A-000 Dimensional Drawing (Unit: mm)

Note: Wiring space needs to be reserved around the driver, it is recommended to be greater than 70mm.

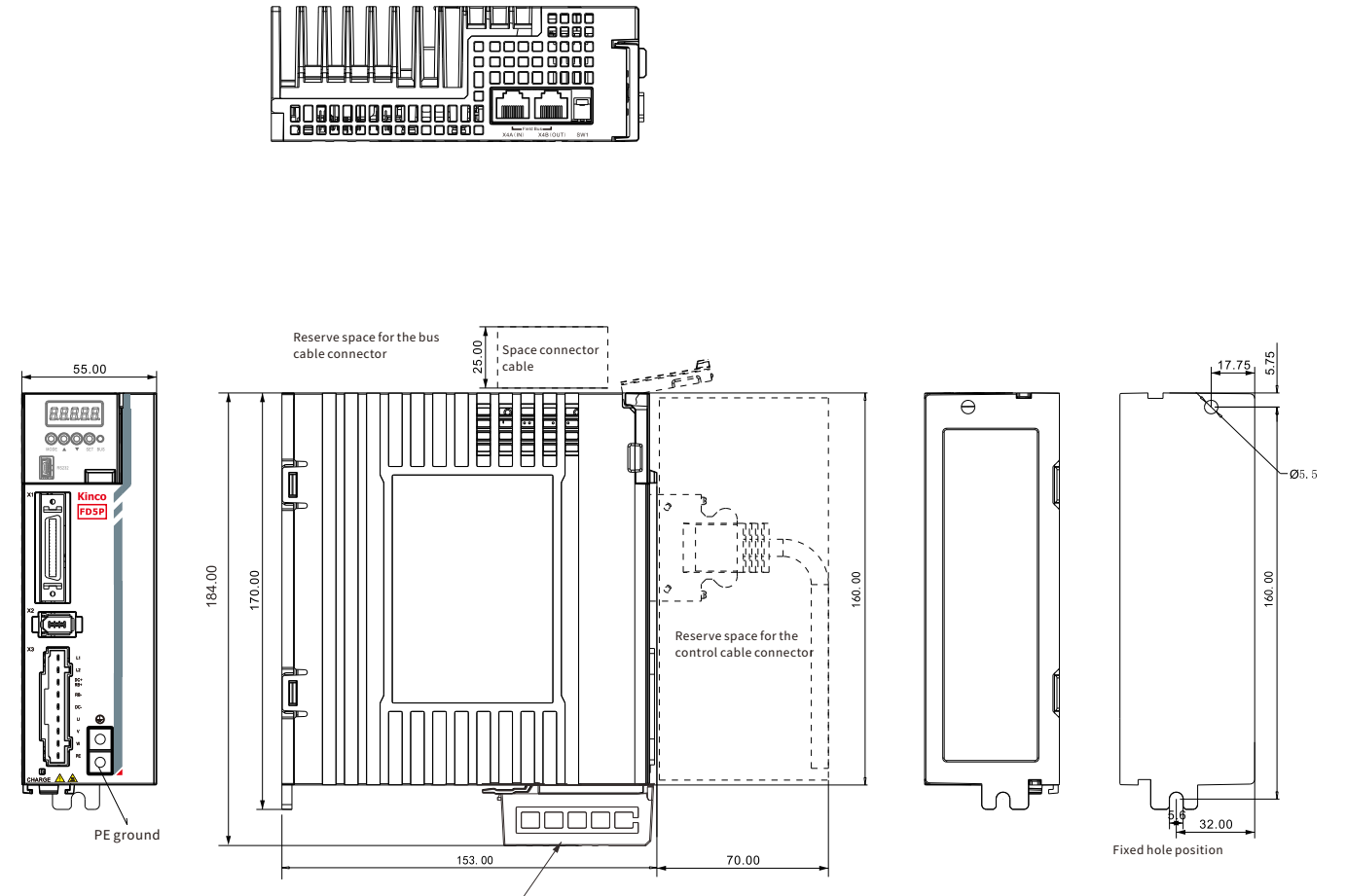

Note: The FD5P battery pack (BAT-FD5) is suitable for the absolute encoder motor and is compatible with ENCDG-LL-GA-DC



## ■ Mechanical dimension diagram of servo drive

### FD425P-□F-000 Dimensional Drawing (Unit: mm)

Note: Wiring space needs to be reserved around the driver, it is recommended to be greater than 70mm.

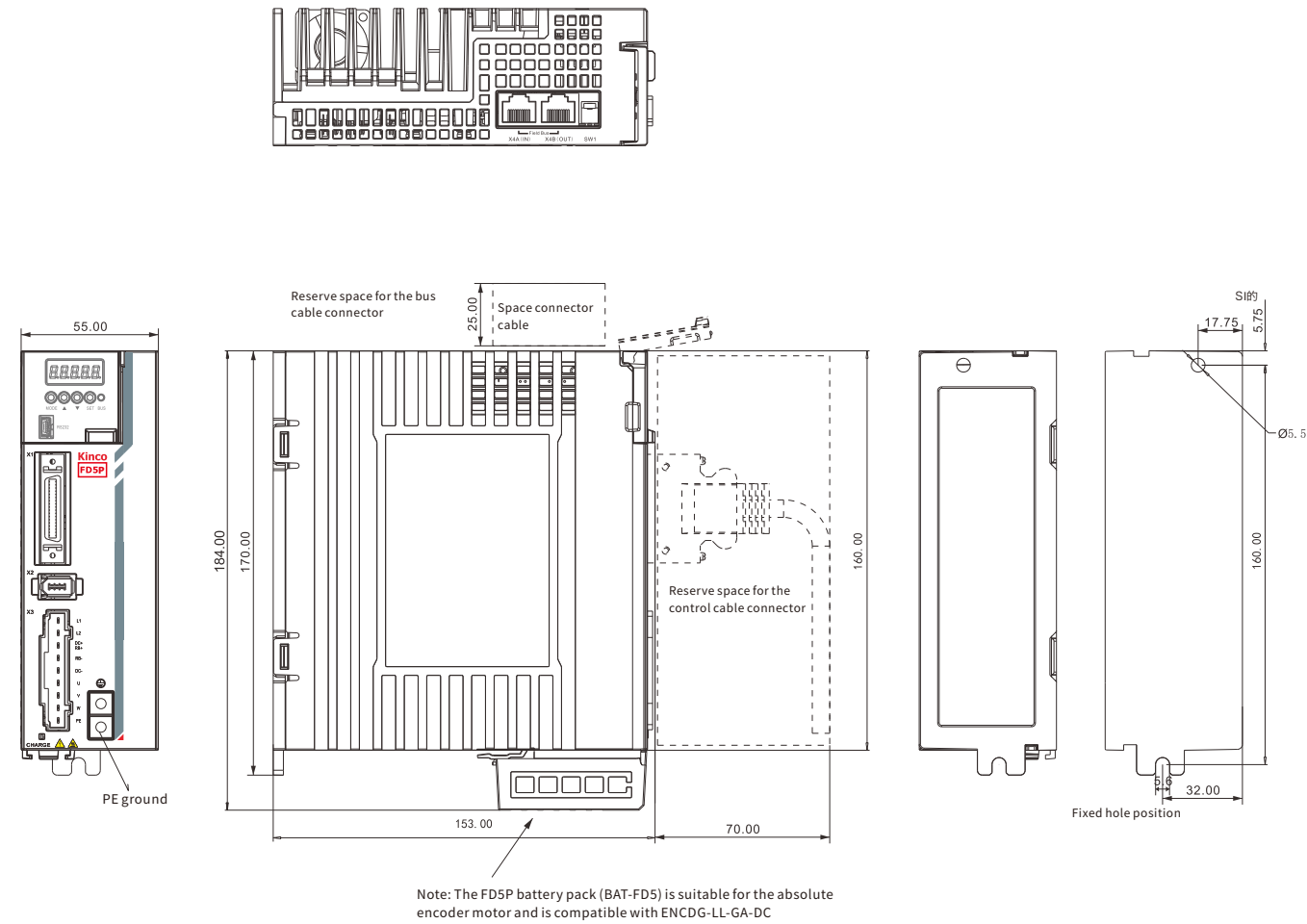

## SMK series high-performance servo motor

### New electromagnetic design

Adopting 12-slot and 10-pole design, with small slot torque and low torque pulsation, which is conducive to reducing the vibration during the operation of the motor and making the torque output more smooth

### New structure and short fuselage

The redesign of the fuselage structure shortens the length of the fuselage, which can save more installation space and reduce the size of the equipment for customers' equipment

### Insulation class F

The motor in the industry is at the highest insulation level, which can maintain high reliability and stability in high temperature extreme environment

### Energy efficiency class: 2

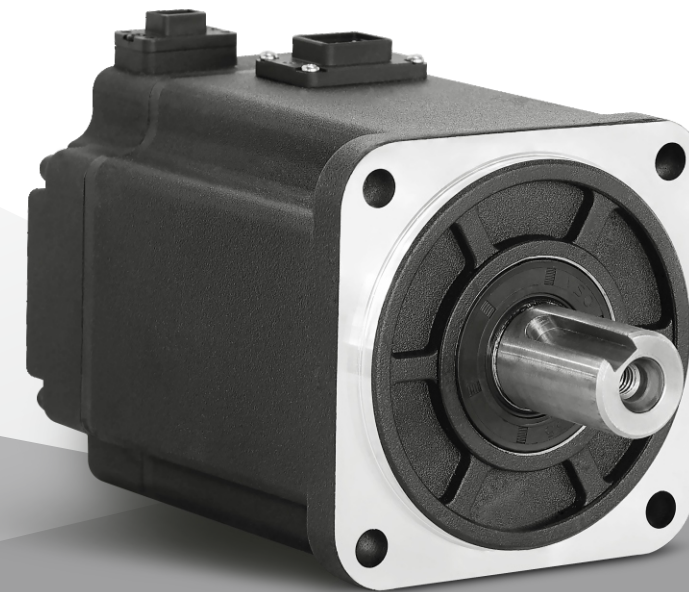

# Dimensional drawing of SMK series servo motor

## Dimensional drawing of SMK series servo motor

40 flange

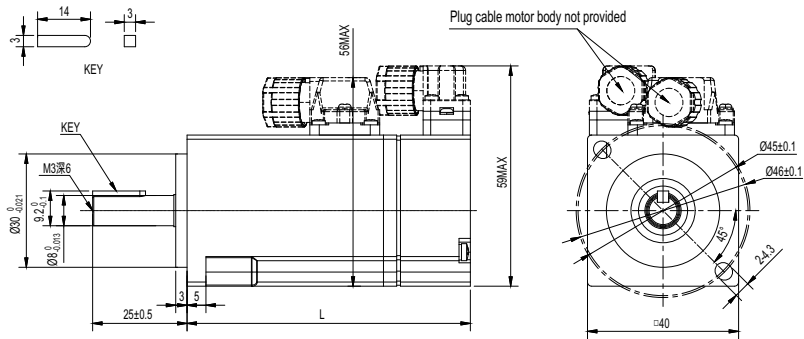

40 flange (with brake)

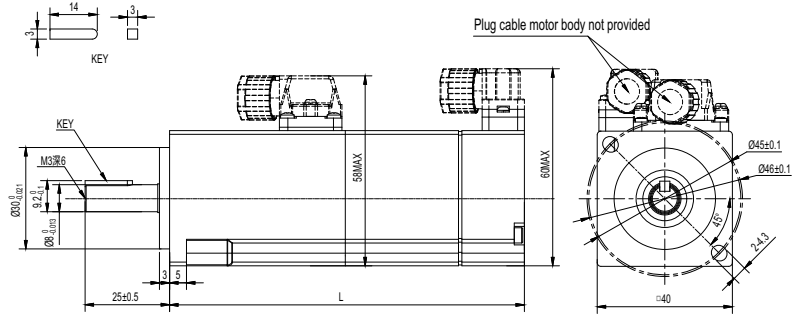

## Dimensional drawing of SMK series servo motor

60 flange

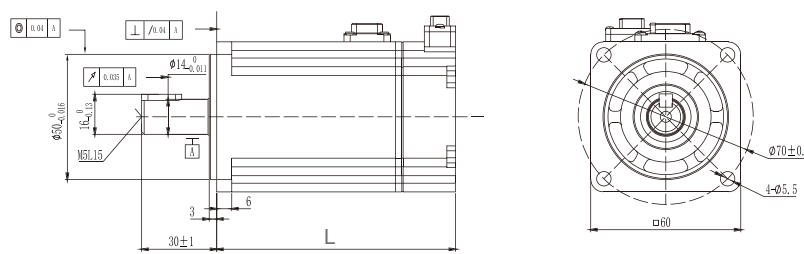

60 flange (with brake)

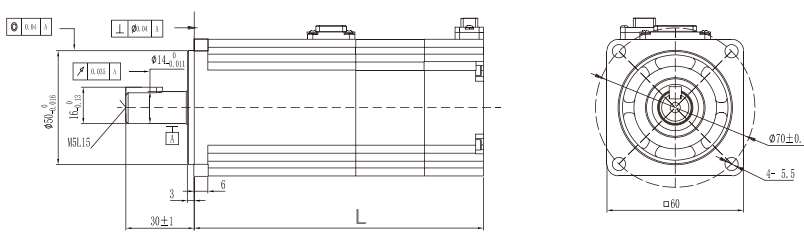

## Dimensional drawing of SMK80 series servo motor

80 flange

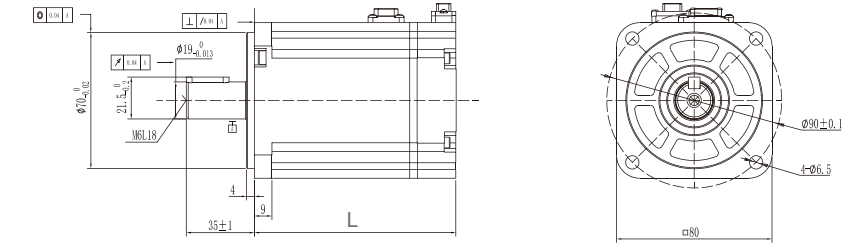

80 flange (with brake)

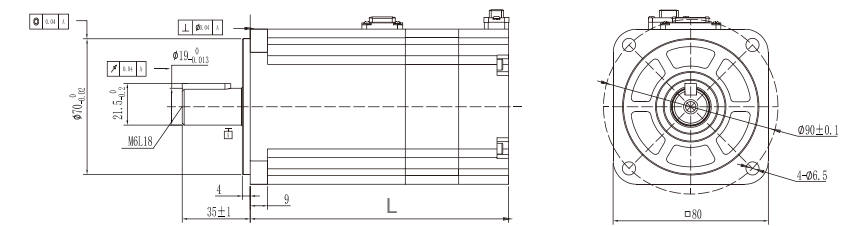

# SMK series servo motor curve diagram

SMK40S-0005-30 K-5LSA 50W

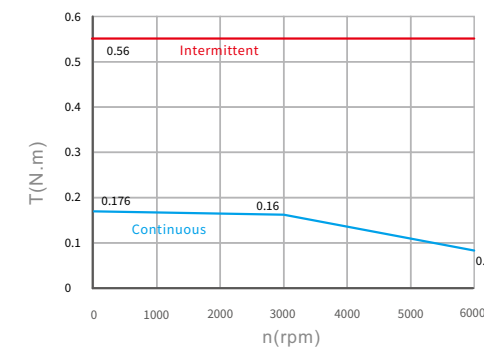

SMK40S-0010-30 K-5LSA 100W

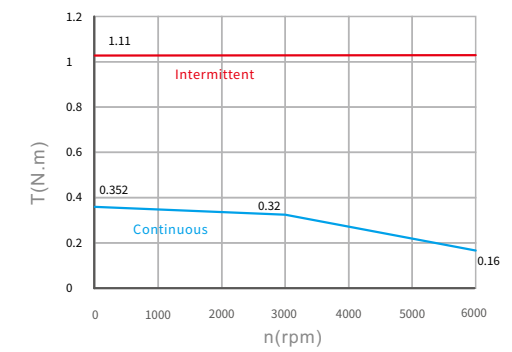

SMK60S-0020-30 K-5LSA 200W

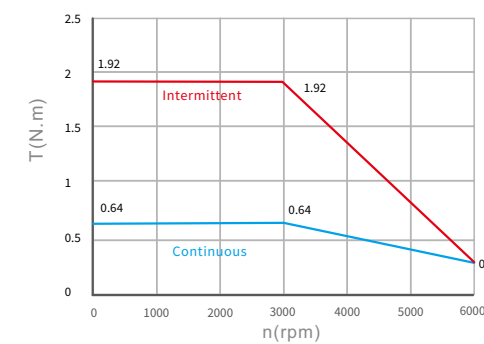

SMK60S-0040-30 K-5LSA 400W

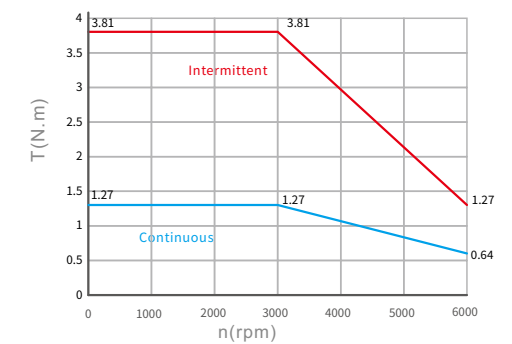

## SMK series servo motor curve diagram

SMK80S-0075-30□■K-5LSA 750W

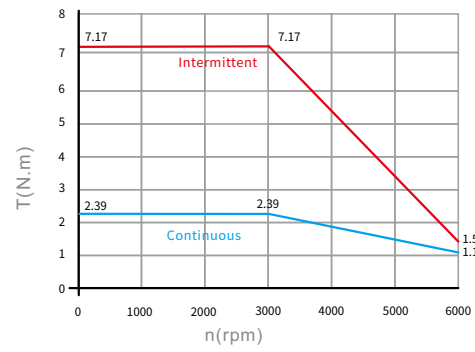

SMK80S-0100-30□■K-5LSA 1000W

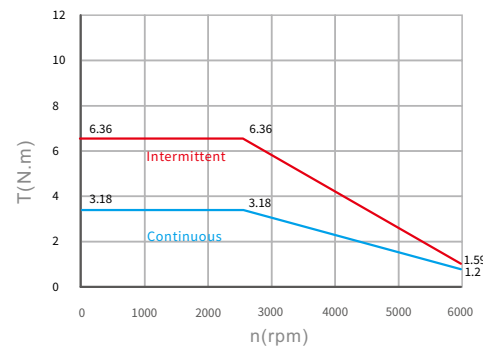

## Connector and wiring at the motor end

Num	Definition
1	U
2	W
3	V
4	PE

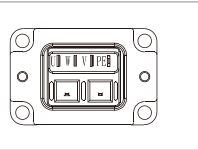

Power socket without brake

Num	Definition
1	DC +5V
2	GND
3	NC
4	NC
5	SD+
6	SD-

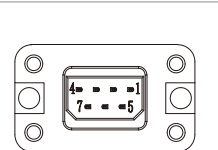

Encoder socket single turn

Num	Definition
1	U
2	W
3	V
4	MOTOR PE
5	BRAKE(+)
6	BRAKE(-)

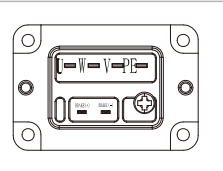

SMK60&80 power socket with brakes

Num	Definition
1	DC +5V
2	GND
3	VB+
4	VB-
5	SD+
6	SD-

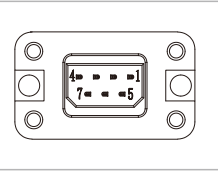

Encoder socket multiturn

Num	Definition
1	U
2	W
3	V
4	PE
5	BRAKE(+)
6	BRAKE(-)

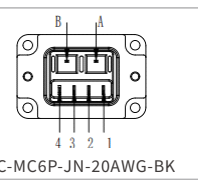

SMK40 power socket with brakes

## Servo Motor Technical Parameters Table

Model Parameters		Small inertia, 40 flange	Small inertia, 40 flange	Small inertia, 60 flange
Servo motor model		SMK40S-0005-30□■K-5LSA	SMK40S-0010-30□■K-5LSA	SMK60S-0020-30□■K-5LSA
Adapted drives		FD415P-LA-000,FD415P-CA-000,FD415P-EA-000		
Drive power supply voltage				
Intermediate link DC voltage UDC		300	300	300
Continuous Characteristics	Rated power Pn(W)	50	100	200
	Rated torque Tn(Nm)	0.16	0.32	0.64
	Rated speed nN (rpm)	3000	3000	3000
	Rated current In(A)	0.88	1.2	1.55
MAX torque Tm(Nm)		0.56	1.11	1.92
MAX current Im (A)		3.3	4.4	5
Standstill torque Ts(Nm)		0.176	0.352	0.71
Standstill current Is(A)		0.98	1.32	1.7
Resistance cable--cable RL(Ω)		13.24	10.78	10.7
Inductance cable--cable LL(mH)		8.027	6.9	20.4
Electrical time constant τe (ms)		0.606	0.64	1.9
Mechanical time constant τm (ms)		1.308	0.952	1.28
		1.42(with brake)	0.996(with brake)	1.31(with brake)
Reverse voltage constant Ke (V/krpm)		12.14	18.18	30
Torque constant Kt (Nm/A)		0.2	0.3	0.5
Rotor moment of inertia Jm (Kg·cm <sup>2</sup> )		0.023	0.044	0.17
		0.025(with brake)	0.046(with brake)	0.174(with brake)
Brake torque T(Nm)		0.32	0.32	2
Number of pole pairs		5	5	5
MAX voltage rising du/dt (KV/μs)		8	8	8
Insulation class		F	F	F
Max radial force Fr(N)		78	78	180
Max axial force Fa(N)		54	54	90
Weight G(Kg)		0.31	0.382	0.85
		0.5(with brake)	0.571(with brake)	1.2(with brake)
Cooling method		Totally enclosed, self-cooling		
Protection level		IP67, IP54 at the shaft end (Note: add oil seal IP54 at the shaft end, no oil seal IP50)		
Operation environment	Temperature	- 20~40°C (no icing)		
	Humidity	Below 90% RH (no condensation)		
	Ambient environment	Keep away from corrosion, flammable gases, oil droplets, dust		
	Altitude	The highest altitude is 4000m. Above 1000m, the power will decrease by 1.5% for every 100m rise.		

Note: □ = M : Singleturn communication type magnetoelectric encoder

Q : Multiturn communication type magnetoelectric absolute encoder

V : Singleturn communication type optical encoder

Y : Multiturn communication type optical absolute value encoder

■ = A : Motor without holding brake

B : Motor with holding brake



# Servo Motor Technical Parameters Table

Model Parameters		Small inertia, 60 flange	Small inertia, 80 flange	Small inertia, 80 flange
Servo motor model		SMK60S-0040-30□■K-5LSA	SMK80S-0075-30□■K-5LSA	SMK80S-0100-30□■K-5LSA
Adapted drives		FD415P-LA-000,FD415P-CA-000	FD425P-LA-000, FD425P-CA-000,FD425P-EA-000	
Drive power supply voltage		FD415P-EA-000		
Intermediate link DC voltage UDC		300	300	300
Continuous Characteristics	Rated power Pn(W)	400	750	1000
	Rated torque Tn(Nm)	1.27	2.39	3.18
	Rated speed nN (rpm)	3000	3000	3000
	Rated current In(A)	2.93	3.9	5.3
MAX torque Tm(Nm)		3.81	7.17	9.54
MAX current Im (A)		9.4	12.4	16
Standstill torque Ts(Nm)		1.4	2.63	3.5
Standstill current Is(A)		3.2	4.3	5.83
Resistance cable--cable RL(Ω)		4.1	1.8	1.4
Inductance cable--cable LL(mH)		8.95	8.2	6.4
Electrical time constant τe (ms)		2.18	4.6	4.6
Mechanical time constant τm (ms)		0.74	0.58	0.57
		0.83 (with brake)	0.62 (with brake)	0.78 (with brake)
Reverse voltage constant Ke (V/krpm)		31	42	40
Torque constant Kt (Nm/A)		0.51	0.7	0.66
Rotor moment of inertia Jm (Kg·cm <sup>2</sup> )		0.274	0.9	1.027
		0.29 (with brake)	0.95 (with brake)	1.41 (with brake)
Brake torque T(Nm)		2	3.2	3.2
Number of pole pairs		5	5	5
MAX voltage rising du/dt (KV/μs)		8	8	8
Insulation class		F	F	F
Max radial force Fr(N)		180	335	335
Max axial force Fa(N)		90	167.5	167.5
Weight G(Kg)		1.3	2	2.3
		1.65 (with brake)	2.6 (with brake)	2.9 (with brake)
Cooling method		Totally enclosed, self-cooling		
Protection level		IP67, IP54 at the shaft end (Note: add oil seal IP54 at the shaft end, no oil seal IP50)		
Operation environment	Temperature	- 20~40°C (no icing)		
	Humidity	Below 90% RH (no condensation)		
	Ambient environment	Keep away from corrosion, flammable gases, oil droplets, dust		
	Altitude	The highest altitude is 4000m. Above 1000m, the power will decrease by 1.5% for every 100m rise.		

Note: □ = M : Singleturn communication type magnetoelectric encoder  
 Q : Multiturn communication type magnetoelectric absolute encoder  
 V : Singleturn communication type optical encoder  
 Y : Multiturn communication type optical absolute value encoder  
 ■ = A : Motor without holding brake  
 B : Motor with holding brake

# Wiring instruction

## ENC DG-LL-GA

Wire specification: 1P22AWG+2P26AWG standard cable  
 22AWG corresponds to a cross-sectional area of 0.3247mm<sup>2</sup>  
 26AWG corresponds to a cross-sectional area of 0.1281mm<sup>2</sup>

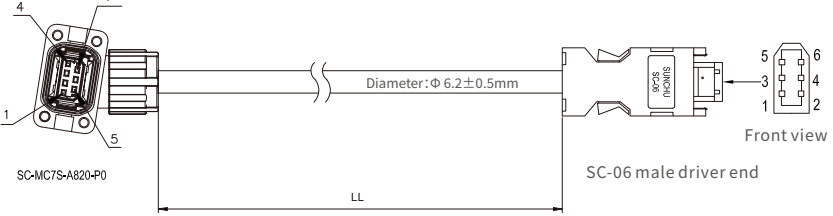

SC-MC7S-A820-P0	Color	Signal 1	Signal 2	SC06 Male
PIN1	red	VDD	VDD	PIN1
PIN2	orange	GND	GND	PIN2
PIN3	brown	MA_P+	/	PIN3
PIN4	black	MA_N-	/	PIN4
PIN5	blue	SLO_P+	SD	PIN5
PIN6	purple	SLO_N-	/SD	PIN6
PIN7	shielded wire	shield	shield	Outer shell

Note:  
 Signal 1 is suitable for magnetoelectric encoders, and signal 1 is suitable for absolute encoders;  
 Corresponding accessory package: ENCDG/ENCDGF-GA

## ENC DGF-LL-GA

Wire specification: 1P22AWG+2P26AWG flexible drag chain cable  
 22AWG corresponds to a cross-sectional area of 0.3247mm<sup>2</sup>  
 26AWG corresponds to a cross-sectional area of 0.1281mm<sup>2</sup>

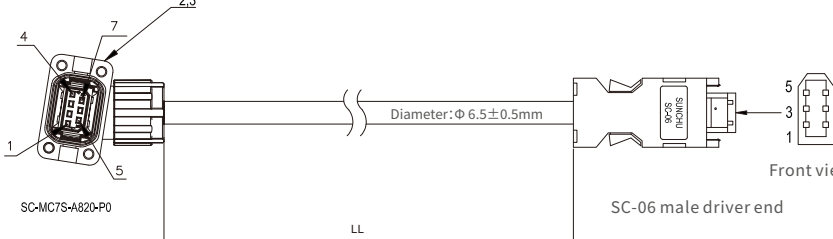

SC-MC7S-A820-P0	Color	Signal 1	Signal 2	SC06 Male
PIN1	red	VDD	VDD	PIN1
PIN2	orange	GND	GND	PIN2
PIN3	brown	MA_P+	/	PIN3
PIN4	black	MA_N-	/	PIN4
PIN5	blue	SLO_P+	SD	PIN5
PIN6	purple	SLO_N-	/SD	PIN6
PIN7	shielded wire	shield	shield	Outer shell

Note:  
 Signal 1 for magnetoelectric encoders, signal 2 for absolute encoders;  
 Corresponding kit: ENCDG/ENCDGF-GA

## ENC DG-LL-GA-DC

Wire specification: 1P22AWG+2P26AWG standard cable  
 22AWG corresponds to a cross-sectional area of 0.3247mm<sup>2</sup>  
 26AWG corresponds to a cross-sectional area of 0.1281mm<sup>2</sup>

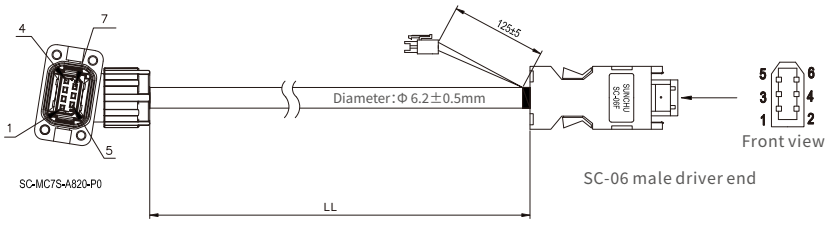

SC-MC7S-A820-P0	Color	Signal 1	Signal 2	SC06 Male
PIN1	red	+5V	/	PIN1
PIN2	orange	GND	/	PIN2
PIN3	brown	BAT+	PIN1	/
PIN4	black	BAT-	PIN2	/
PIN5	blue	SD	/	PIN5
PIN6	purple	/SD	/	PIN6
PIN7	shielded wire	shield	/	Outer shell

Note:  
 BAT-FD5 is suitable for absolute encoder motors and is used in conjunction with ENCDG-LL-GA-DC  
 FD5P battery case optional package

## ENC DGF-LL-GA-DC

Wire specification: 1P22AWG+2P26AWG flexible drag chain cable  
 22AWG corresponds to a cross-sectional area of 0.3247mm<sup>2</sup>  
 26AWG corresponds to a cross-sectional area of 0.1281mm<sup>2</sup>

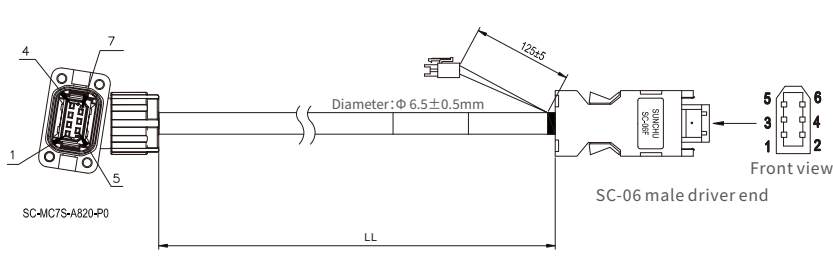

SC-MC7S-A820-P0	Color	Signal 1	Signal 2	SC06 Male
PIN1	red	+5V	/	PIN1
PIN2	orange	GND	/	PIN2
PIN3	brown	BAT+	PIN1	/
PIN4	black	BAT-	PIN2	/
PIN5	blue	SD+	/	PIN5
PIN6	purple	SD-	/	PIN6
PIN7	shielded wire	shield	/	Outer shell

Note:  
 BAT-FD5 is suitable for absolute encoder motors and is used in conjunction with ENCDGF-LL-GA-DC  
 FD5P battery case optional package

# Wiring instruction

## MOT-005-LL-KA

Wire specification: 4C \* 20AWG 300V standard cable  
20AWG corresponds to a cross-sectional area of 0.5189mm<sup>2</sup>

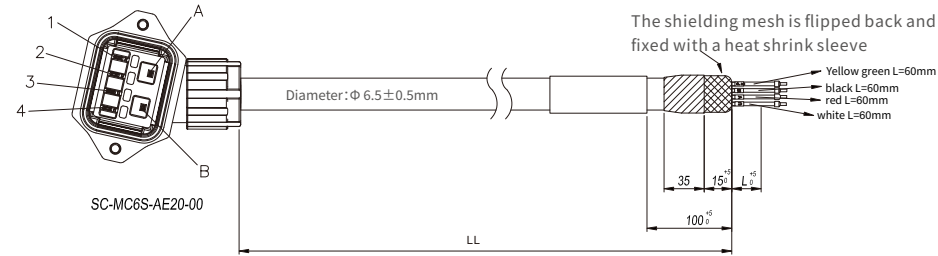

SC-MC6S-AE20-00	Color	Signal
PIN1	white	U
PIN2	black	W
PIN3	red	V
PIN4	Yellow green+shield	PE

Remarks:  
Corresponding accessory package MOT/MOTF-005-KA

## MOTF-005-LL-KA

Wire specification: 4C \* 20AWG 300V flexible drag chain cable  
20AWG corresponds to a cross-sectional area of 0.5189mm<sup>2</sup>

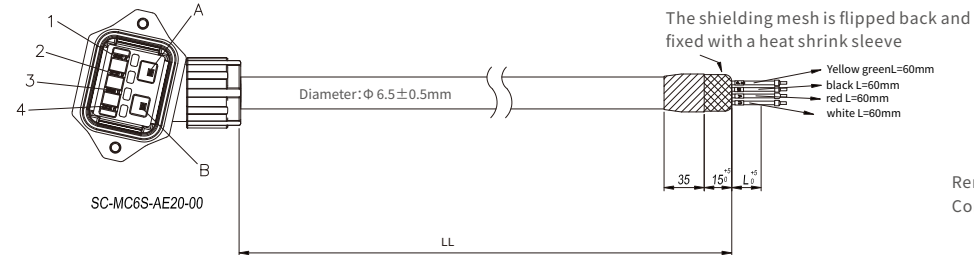

SC-MC6S-AE20-00	Color	Signal
PIN1	white	U
PIN2	black	W
PIN3	red	V
PIN4	Yellow green+shield	PE

Remarks:  
Corresponding accessory package MOT/MOTF-005-KA

## MOT-005-LL-KA-NS

Wire specification: 4C \* 20AWG 300V standard cable, unshielded  
20AWG corresponds to a cross-sectional area of 0.5189mm<sup>2</sup>

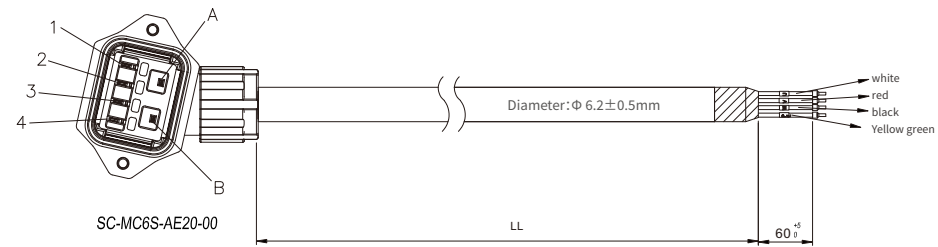

SC-MC6S-AE20-00	Color	Signal
PIN1	white	U
PIN2	black	W
PIN3	red	V
PIN4	Yellow green+shield	PE

Remarks:  
Corresponding accessory package MOT/MOTF-005-KA

## MOTF-005-LL-KA-NS

Wire specification: 4C \* 20AWG 300V Standard cable, unshielded  
20AWG corresponds to a cross-sectional area of 0.5189mm<sup>2</sup>

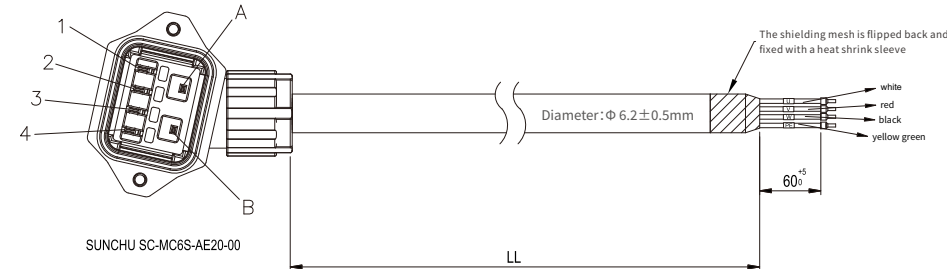

SC-MC6S-AE20-00	Color	Signal
PIN1	white	U
PIN2	black	W
PIN3	red	V
PIN4	yellow green	PE

# Wiring instruction

## MOT-005-LL-KA-B

Wire specification: 4C \* 18AWG+1P \* 24AWG flexible drag chain cable  
18AWG corresponds to a cross-sectional area of 0.8107mm<sup>2</sup>  
24AWG corresponds to a cross-sectional area of 0.2047mm<sup>2</sup>

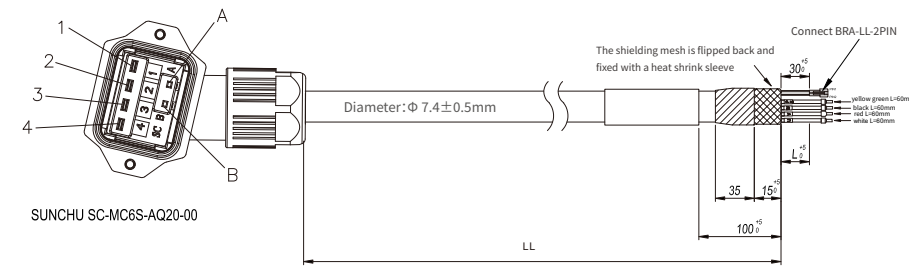

SC-MC6S-AQ20-00	C2505HM-02P	Color	Signal
PIN1	/	white	U
PIN2	/	black	W
PIN3	/	red	V
PIN4	/	yellow green+shield	PE
PINA	PIN1	brown	BRAKE(+)
PINB	PIN2	blue	BRAKE(-)

Remarks:  
Corresponding accessory package MOT/MOTF-005-KA-B

## MOTF-005-LL-KA-B

Wire specification: 4C \* 18AWG+1P \* 24AWG Shielding, flexible towing chain  
18AWG corresponds to a cross-sectional area of 0.8107mm<sup>2</sup>

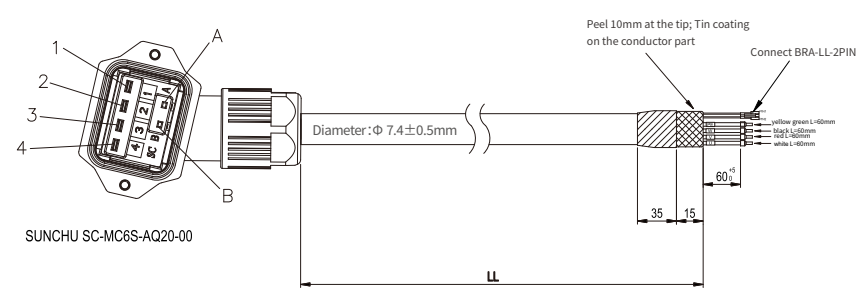

SC-MC6S-AQ20-00	C2505HM-02P	Color	Signal
PIN1	/	white	U
PIN2	/	black	W
PIN3	/	red	V
PIN4	/	yellow green+shield	PE
PINA	PIN1	brown	BRAKE(+)
PINB	PIN2	blue	BRAKE(-)

Remarks:  
Corresponding accessory package MOT/MOTF-005-KA-B

## MOTF-005-LL-KAB-S

Wire specification: 4C \* 20AWG 300V flexible drag chain cable  
20AWG corresponds to a cross-sectional area of 0.5189mm<sup>2</sup>  
24AWG corresponds to a cross-sectional area of 0.2047mm<sup>2</sup>

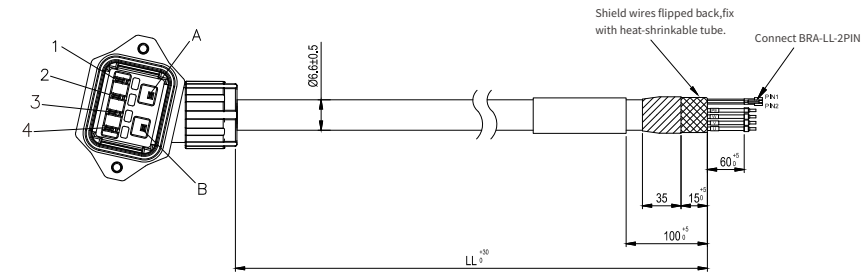

SC-MC6S-AE20-00	C2505HM-02P	Color	Signal
PIN1	/	white	U
PIN2	/	black	W
PIN3	/	red	V
PIN4	/	yellow green+shield	PE
PINA	PIN1	brown	BRAKE(+)
PINB	PIN2	blue	BRAKE(-)

## BRA-LL-2PIN

Wire specification: 1P \* 24AWG standard cable with shielding  
24AWG corresponds to a cross-sectional area of 0.2047mm<sup>2</sup>

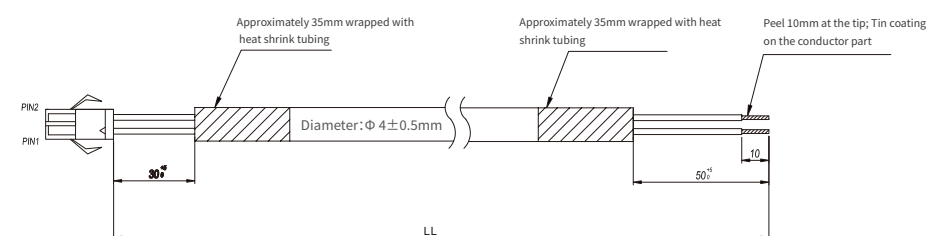

C2505HF-02P	Color	Signal
PIN1	brown	BRAKE(+)
PIN2	blue	BRAKE(-)

Remarks: Used with MOT-005-LL-KA-B